

Excelsior



BBQ Rangehoods

Model No.
CXWB12082BLK, CXWB14802BLK
and CXWB14802IS

Suits most 4 and 6 burner BBQ's
Maximum 2600m³/hr (CXWB12082BLK) airflow
Maximum 3900m³/hr airflow
Super bright LED lighting
Stainless steel baffle filters
For outdoor use only

Important: Retain these instructions for future use.

WARRANTY TERMS & CONDITIONS

This warranty is not transferable to a subsequent purchaser if the product is sold by the original purchaser during the warranty period.

If a warranty fault appears within the warranty period, S.G.A. reserves the right to replace or repair the product.

In the event that S.G.A. chooses to replace the product, this original warranty will expire at the original date.

If the product includes various accessories or components, only the defective accessory or component will be replaced or repaired.

S.G.A. Reserves the right to replace defective parts of the product with parts and components of similar quality, grade and composition where an identical part or component is not available.

Products presented for repair may be replaced by refurbished products of the same type rather than being repaired. Refurbished parts may be used to repair the products.

To make a warranty claim, first contact S.G.A.'s Customer Service Line on the contact number below.

The purchase receipt for this product is to be retained and must be presented if making claim under the terms of this S.G.A. warranty.

Warranty repairs are free of charge, provided the product is delivered to our Service Department at 33-35 Lionel Road, Mt Waverley, Victoria, 3149 or to one of our Authorised Service Agents.

If a warranty fault is found the freight cost will be credited to the owner. If no fault is found the product will be returned and any costs associated with the service will be charged to the owner.

Products sent freight forward will not be accepted. In most cases the defective accessory or component only will need to be returned. The product or part of the product being returned must be adequately protected in a box.

S.G.A. will not be responsible for any in-transit loss or damage.

This warranty does not apply to any defect, deterioration,

loss, injury or damage occasioned by or as a result of misuse or abuse, negligent handling or storage, normal wear and tear or if the product has not been installed and used in accordance with S.G.A.'s instructions, recommendations and specifications or if the product has been subjected to abnormal conditions. The warranty does not apply to blockages caused by insects or living organisms, as well as incorrectly installed ducts.

The warranty is void if there is evidence of the product being tampered with by unauthorised persons. The warranty does not extend to installation or disconnection costs.

Our goods come with guarantees that cannot be excluded under the Australian Consumer Law. You are entitled to a replacement or refund for a major failure and for compensation for any other reasonably foreseeable loss or damage. You are also entitled to have the goods repaired or replaced if the goods fail to be of acceptable quality and the failure does not amount to a major failure. The benefits of this warranty are in addition to any rights and remedies imposed by Australian State and Federal legislation that cannot be excluded.

Product Approved For Outdoor Use Only

For warranty claims, service, spare parts or products information in Australia, please call SITRO GROUP AUSTRALIA Pty Ltd on the Customer Service Line 1300 174 876.

A receipt or proof of purchase is required and must be kept for your records.

CONTACT DETAILS

Sitro Group Australia Pty Ltd
33-35 Lionel Road, Mt. Waverley
Victoria 3149, Australia
Tel (+613) 9543 9533
Fax (+613) 9543 9839
service.group@sitro.com.au

For any queries or assistance call



**Customer Service
Australia Only**

1300 174 876

Hours of operation:

Monday to Friday 8am - 5pm EST

Do not return to place of purchase.

60 Months Warranty Offer*

*24 Month Standard Warranty + 36 Month Extended warranty. Available when installation is completed by one of our recommended installers.



Scan QR code to view installer list and register your extended warranty.

INSTALLATION - OUTDOOR USE ONLY

Read all instructions before installing and operating this Rangehood.

This Rangehood is designed for use above an outdoor domestic gas (propane/natural) barbecue.

WHAT IS AN OUTDOOR AREA

An outdoor area is an open-air situation that is not obstructed by buildings, structures etc, facilitating correct combustion and allowing products of combustion to be readily dispersed to atmosphere.

An alfresco area, veranda or balcony (large area) is considered outdoors when it is an open-air situation with natural ventilation. This ensures stagnant areas do not form, as these prevent the products of combustion from being rapidly dispersed by wind and natural convection. In the unlikely event of a gas leak occurring, a well-ventilated area will allow escaping gases to rapidly disperse.

The following situations are considered to provide the natural ventilation required for an outdoor domestic barbecue or patio heater to be used:

- Four open sides with a roof or overhead cover.
- Four enclosed sides (walls) without a roof or overhead cover.
- Two parallel walls or two walls at right angles to each other with a roof or overhead cover.
- Three walls, with the one open side being at least 25 per cent of the total perimeter and the remaining three walls having an area of 30 per cent or more of unrestricted opening, with a roof or overhead cover.

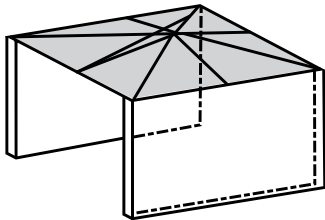

Parallel Walls

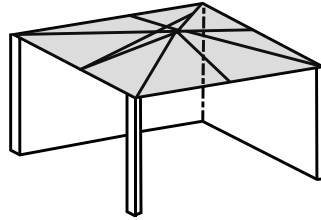

Right Angle Walls

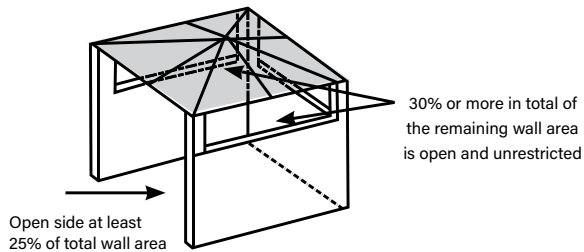

Electrical Data IMPORTANT SAFETY RULES

This rangehood is fitted with a sealed electrical connection plug that is compatible with the mains power supply for Australia / New Zealand and meets the requirements of Australian Standards. This rangehood must be connected to a supply voltage that is equal to that stated on the rating label. If the mains power connection plug or power cord becomes damaged it must be replaced with a complete assembly that is identical to the original, and this must be replaced by an authorised service centre. Always follow the Australian / New Zealand requirements for connection to the mains supply. If in doubt always consult a qualified electrician.

INSTALLATION - OUTDOOR USE ONLY

BALCONIES & VERANDAS

An outdoor barbecue or rangehood may be installed and used on a balcony or veranda if, by location and use, it will not cause a hazard and the manufacturer's instructions allow for such use. It may also be necessary to consult local building laws before installing or using a gas barbecue on a balcony or veranda.

A balcony or veranda shallow in depth and with a roof and three enclosed sides is considered an acceptable area if the following applies:

- the depth of the balcony or veranda is smaller than or equal to its height; and
- the open face width is at least twice the depth.

Examples of these situations:

- A balcony with an open construction balustrade (more than 75 per cent free open area). Measure the distance from floor to roof 'H'.
- The maximum allowable depth 'D' is the same as 'H' and the minimum width 'W' is twice 'D'.
- A balustrade is enclosed or has less than 75 per cent free open area. Measure from the top of the balustrade to the roof 'Ha'. The maximum allowable depth 'D' is the same as 'Ha' and the minimum width 'W' is twice 'D'.

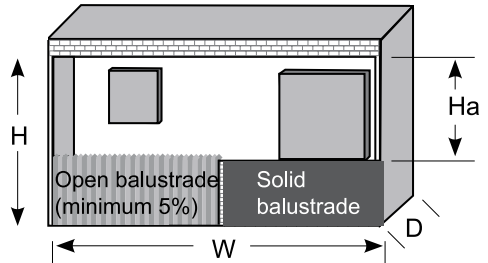

IMPORTANT

It is recommended that access doors or windows to the balcony or veranda be closed while the barbecue is in use. If unsure always consult with your local building authority and local gas authority.



WARNING - SAFETY NOTICE

This appliance is not intended for use by persons (including children) with reduced physical, sensory or mental capacities, or lack of experience and knowledge, unless they have been given supervision or instruction concerning use of the appliance by a person responsible for their safety.

Young children should be supervised to ensure that they do not play with the appliance.

There shall be adequate ventilation of the room when the Rangehood is used at the same time as appliances burning gas or other fuels.

There is a fire risk if cleaning is not carried out in accordance with the instructions. You must read the details the details concerning the method and frequency of cleaning.

Do not flambé under the Rangehood.

Exhaust air must not be discharge into an existing flue which is used for exhausting fumes from appliances burning gas or other fuels.

The minimum distance between the hob surface/ BBQ cooking surface and the lowest part of the Rangehood shall be 1200mm. If the instructions for the barbecue or the current revision of AS/NZS5601.1 specify a greater distance, this must be considered.

Attention should be given to ensure that any applicable regulations concerning the discharge of exhaust air are fulfilled.

Note that accessible parts may become hot when used with cooking appliances.

Always ensure this Rangehood is installed as per the requirements noted in the current revision of AS/NZS3000 (Wiring Rules).

If the supply cord of this equipment is damaged, it must only be replaced by the manufacturer or its service agent or a similarly qualified person in order to avoid a hazard.

Range hoods and other cooking fume extractors may adversely affect the safe operation of appliances burning gas or other fuels (including those in other rooms) due to back flow of combustion gases. These gases can potentially result in carbon monoxide poisoning. After installation of a range hood or other cooking fume extractor, the operation of flued gas appliances should be tested by a competent person to ensure that back flow of combustion gases does not occur.

WARNING: Failure to install the screws or fixing the device in accordance with these instructions may result in electrical hazards



IMPORTANT - PRIOR TO INSTALLATION

Please read the entire instruction manual before installing the Rangehood.

The installation in this manual is intended for qualified installers, service technicians or persons with similar qualified backgrounds. DO NOT attempt to install this appliance yourself. Injury could result from installing the unit due to lack of appropriate electrical and technical background.

Always switch power off prior to installation.

For safety, this product must be earthed.

A power outlet should be within 1000mm of the power cord exit from the Rangehood.

The socket must be accessible and enable the end user to isolate the Rangehood from the power for the purpose of internal cleaning or maintenance.

Stainless steel or powder coat is very easily damaged during installation if abraded or knocked by tools. Protect the Rangehood with the cardboard box or plastic bag during installation.

All ducting must comply with local requirements, building codes and gas codes.

It is not recommended to use old duct work.

It should be replaced if necessary to avoid the possibility of a grease fire. Check all joints on duct work to ensure proper connection all joints should be properly taped.

The Rangehood is designed for outdoor undercover use only and must be in a dry location.

Suitable fixings will be required to mount this Rangehood. These are not included.

The power supply must be supplied though a residual current device (RCD) having a tripping current not exceeding 30mA.

Incorrect installation is not covered under warranty.



CAUTION - PRIOR TO AND DURING USE

Remove any plastic coating from the product before use.

Underside surfaces can become hot during use. Do not touch.

Never leave barbecue unattended during use as fat fires and flare ups may occur.

Always operate the product from a power source of the same Voltage, Frequency and Rating as indicated on the Product Identification Plate.

Avoid leaving Rangehood operating when unattended.

Avoid contact with moving parts. Keep hands, hair and clothing, well away from the product while it is in operation.

Do not attempt to modify this appliance as this could cause injury and will void your warranty.

Do not use the product for other than its intended use as described in these instructions. This product is intended for Normal Domestic Household Use only.

Rangehood. These are not included.

The power supply must be supplied through a residual current device (RCD) having a tripping current not exceeding 30mA.

Incorrect installation is not covered under warranty.



CAUTION - FILTERS

The appliance is fitted with removable filters. DO NOT remove filters whilst Rangehood is operating.

Ensure the filters are removed and thoroughly cleaned at least once every two months, every 30 hours of operation or when clearly dirty (whichever comes first) in accordance with the instructions in the section CLEANING.

There is a fire risk if cleaning is not carried out in accordance with the instructions

SUPPLIED MATERIALS

ITEM No	CXWB12082BLK	CXWB14802BLK	CXWB14802IS
Rangehood (w/Duct Adapters fitted to each Motor)	1	1	1
400mm high Flue Covers	2	2	2
Chimney Mounting Bracket	1	1	-
Roof Mounting Bracket	-	-	1
Semi-rigid Ø150mm Ducting	2	3	3
Hardware to attach Brackets	1	1	1

REQUIRED FOR USE

Accessible power pointed fitted within 1m of Rangehood mounting position. The power point must be supplied through a residual current device (RCD) having a tripping current not exceeding 30mA.

TYPICAL EQUIPMENT REQUIRED FOR INSTALLATION

- Electric drill
- Suitable mounting hardware
- Drills
- Screwdriver
- Tape measure/rule
- Plumb bob
- Spirit level
- Ladder

For ducting:

- Duct tape
- Jigsaw
- Duct elbows as required for correct installation
- Roof cap or duct exit as required for correct installation

BEFORE INSTALLING

Please consider the following important items before commencing to install the rangehood:

1. The rangehood must be ducted to an external exit point to ensure it operates and complies with local and national regulations. Vertical exit through the roof is highly recommended to provide the best performance, (See Diagram 1).
2. Avoid sharp bends in the duct – ideal bend radius should be at least 2 x duct diameter (R300mm minimum), (See Diagram 2).
3. The rangehood should be sized to larger than the cooking surface of the BBQ (including any side burners) to ensure adequate extraction of smoke and fumes, (See Diagrams 3 & 4).
4. When fitted above a BBQ with hood, consideration should be taken to create a bulkhead behind the Wall Mounted rangehood to bring it forward from where the open hood is. This will ensure the best extraction of the smoke and fumes and minimise impact of hood deflecting smoke away from the rangehood, The Ceiling Mounted rangehood needs to be mounted forward of the BBQ hood, (See Diagrams 5 & 6).
5. Each fan motor must be ducted separately (do not combine to a single outlet).
6. Do not reduce the duct size smaller than $\text{Ø}150\text{mm}$.
7. Total length to exits is recommended to be less than 4m.
8. Do not crush, compress or deform the duct.

Diagram 1:
RANGEHOOD EXIT

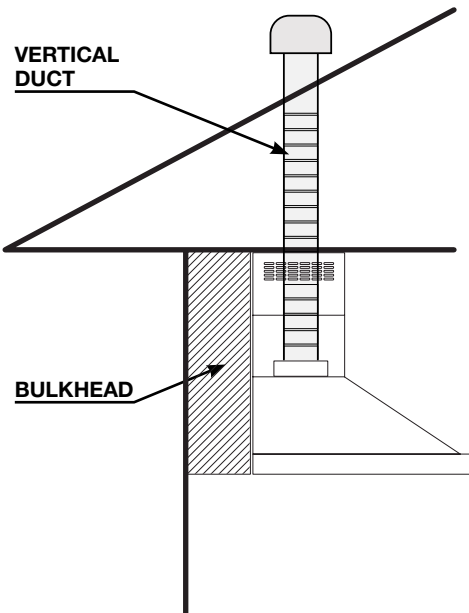

WARNING - FIRE

NEVER Exhaust air or terminate duct work into spaces between walls, crawl spaces, ceilings, attics or garages. All exhaust must be ducted to the atmosphere.

Use Metal duct work only.

Fasten all connections with sheet metal screws and tape all joints with certified Silver tape or duct tape.

The rangehood kit includes semi-rigid aluminium ducting. In the case additional ducting is required, it is highly recommended that semi-rigid aluminium ducting or fully rigid metal duct is used. Fully rigid metal ducting will further improve the airflow of the rangehood

Diagram 2:
DUCT BENDS

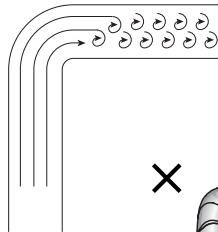

NOT IDEAL – Avoid sharp bends and crushed or compressed duct as it will restrict airflow.

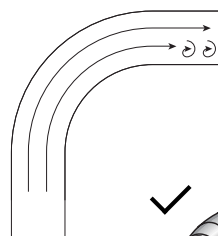

IDEAL – If bends are needed, gradual bends with radius at least twice the duct diameter and taut ducting allow for the best airflow.

RANGEHOOD SIZING AND POSITION

Diagram 3:
SIZED TOO
SMALL

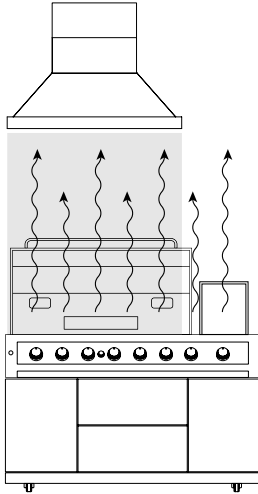

NOT IDEAL – Rangehood does not overlap with BBQ cooking area and smoke and fumes can easily escape away from the rangehood.

Diagram 4:
SIZED
CORRECTLY

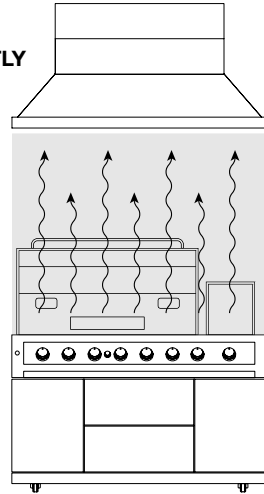

IDEAL – Rangehood overlaps complete cooking area of the BBQ to help ensure it captures the maximum level of fumes and smoke.

WALL MOUNTED

Diagram 5:
SMOKE
ESCAPES
RANGEHOOD

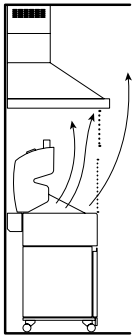

NOT IDEAL - Hood deflects smoke and fumes and away from the rangehood.

Diagram 6:
FORWARD TO
COMPENSATE
FOR BBQ HOOD



BULKHEAD

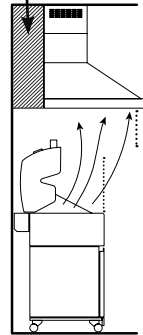

IDEAL – Bulkhead to allow rangehood to be positioned slightly forward of the cooking area to catch smoke and fumes effectively.

CEILING MOUNTED

Diagram 5:
SMOKE
ESCAPES
RANGEHOOD

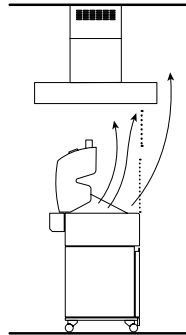

NOT IDEAL - Hood deflects smoke and fumes and away from the rangehood.

Diagram 6:
FORWARD TO
COMPENSATE
FOR BBQ HOOD

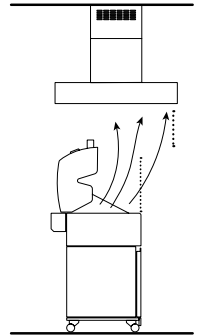

IDEAL – Positioned slightly forward of the cooking area to catch smoke and fumes effectively.

INSTALLING - WALL MOUNT CXWB12082BLK RANGEHOOD

Mounting bracket is attached and part of the range hood motor cover. Note: range hood must be level, if not range hood will not operate correctly.

1. Using a tape measure mark the centre hole (A) on your wall. This mark should be in the centre of your cooking surface and 1686mm above your cooking surface.
2. Using a tape measure and level mark the other holes on your wall. Ensure all of these are level.
3. Your range hood is very heavy. Please use suitable fixings and hole size for this weight.
4. If unsure of which fixings please discuss with your hardware stockist or range hood installer.
5. Using two people lift range hood into place and secure to the wall using selected hardware. Ensure range hood is level.
6. Securely fix the range hood bracket to a solid wall. Ensure it is level before tightening the fixings.

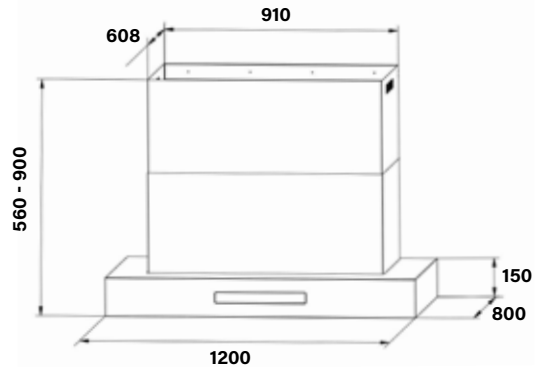

BRACKET MEASUREMENTS

(all measurements are in millimetres.)

CXWB12082BLK

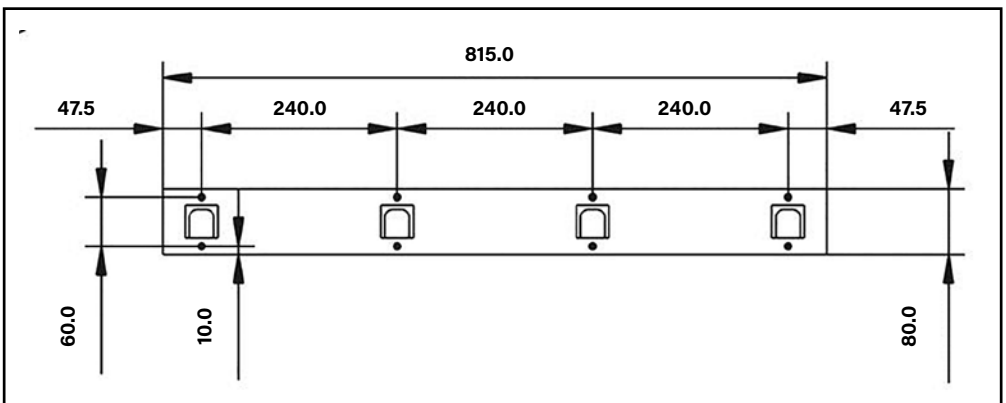

WALL MOUNT CXWB12082BLK RANGEHOOD

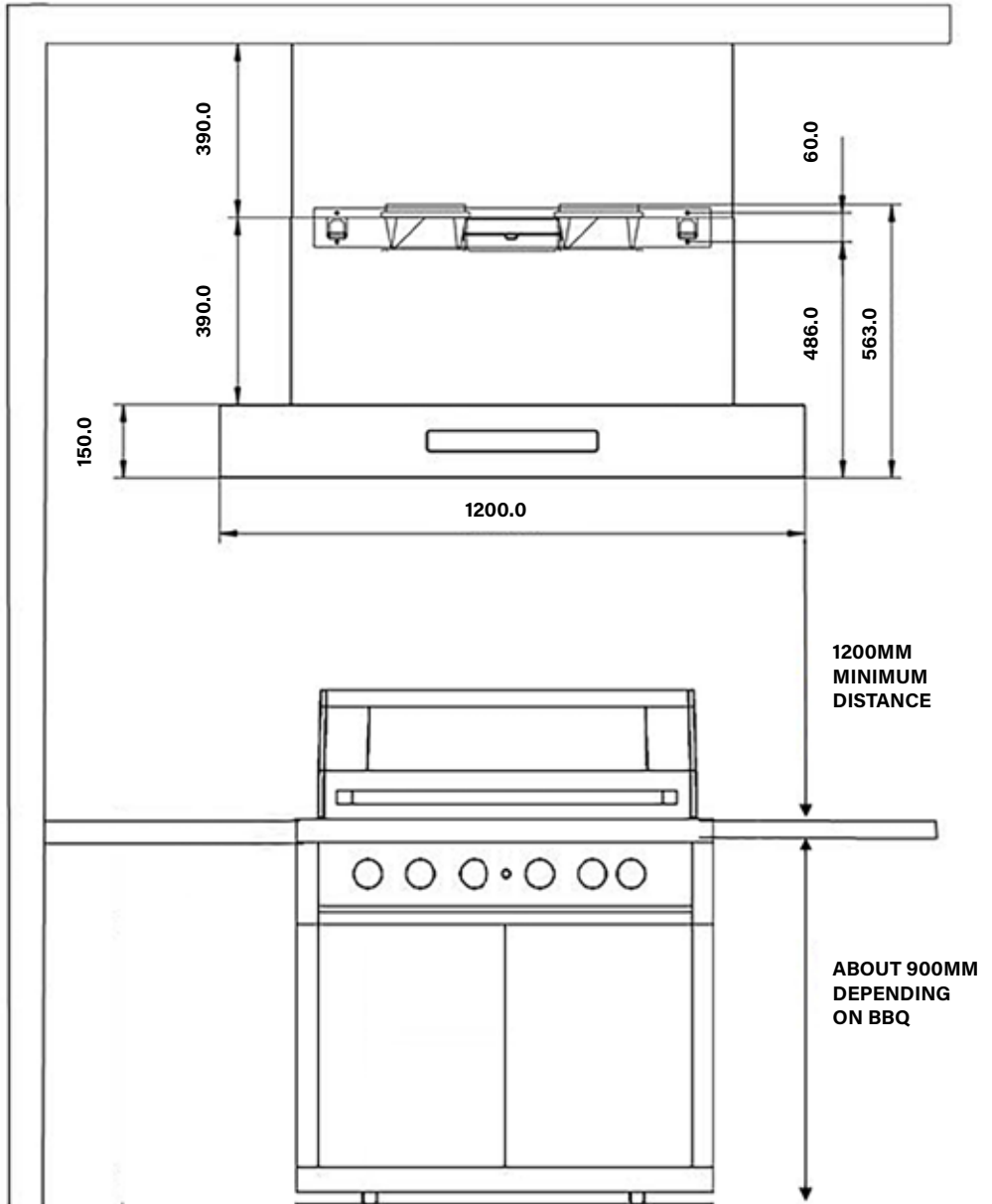

INSTALLING - WALL MOUNT CXWB14802 & CXWB14802BLK RANGEHOOD

WALL BRACKET

Note: Bracket must be level, if not range hood will not operate correctly.

1. Using a tape measure mark the centre bottom hole (A) on your wall. This mark should be in the centre of your cooking surface and 1685mm above your cooking surface.
2. Position the wall bracket with the centre bottom hole (A) over the mark you have just made.
3. Ensure bracket is level using spirit level.
4. Once level mark the remaining holes on your wall.
5. Your range hood is very heavy. Please use suitable fixings and hole size for this weight. If unsure of which fixings please discuss with your hardware stockist or range hood installer.
6. Securely fix the range hood bracket to a solid wall. Ensure it is level before tightening the fixings.

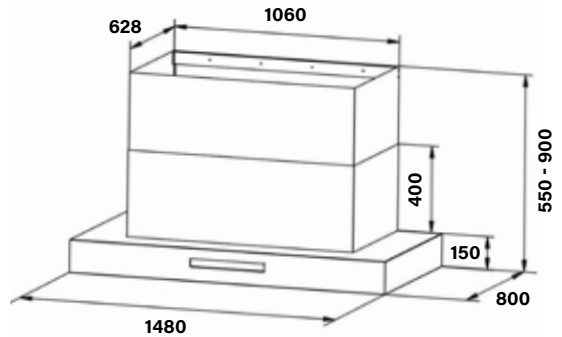

BRACKET MEASUREMENTS

(all measurements are in millimetres.)

CXWB14802 & CXWB14802BLK

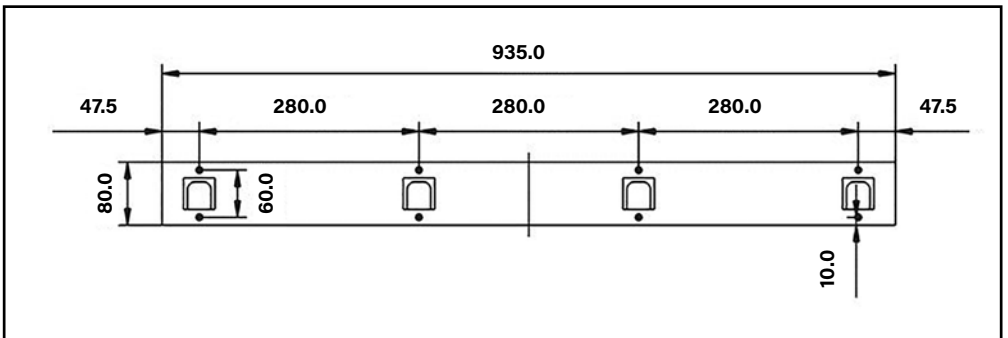

FITTING

1. Lift and position the Range hood so that the wall bracket slides into all lifting holes on the top wall side of the motor box.
2. Check to ensure that the Range hood is level side to side as well as front to back. It is imperative that the Range hood is level so that it operates correctly.

WALL MOUNT CXWB14802BLK RANGEHOOD

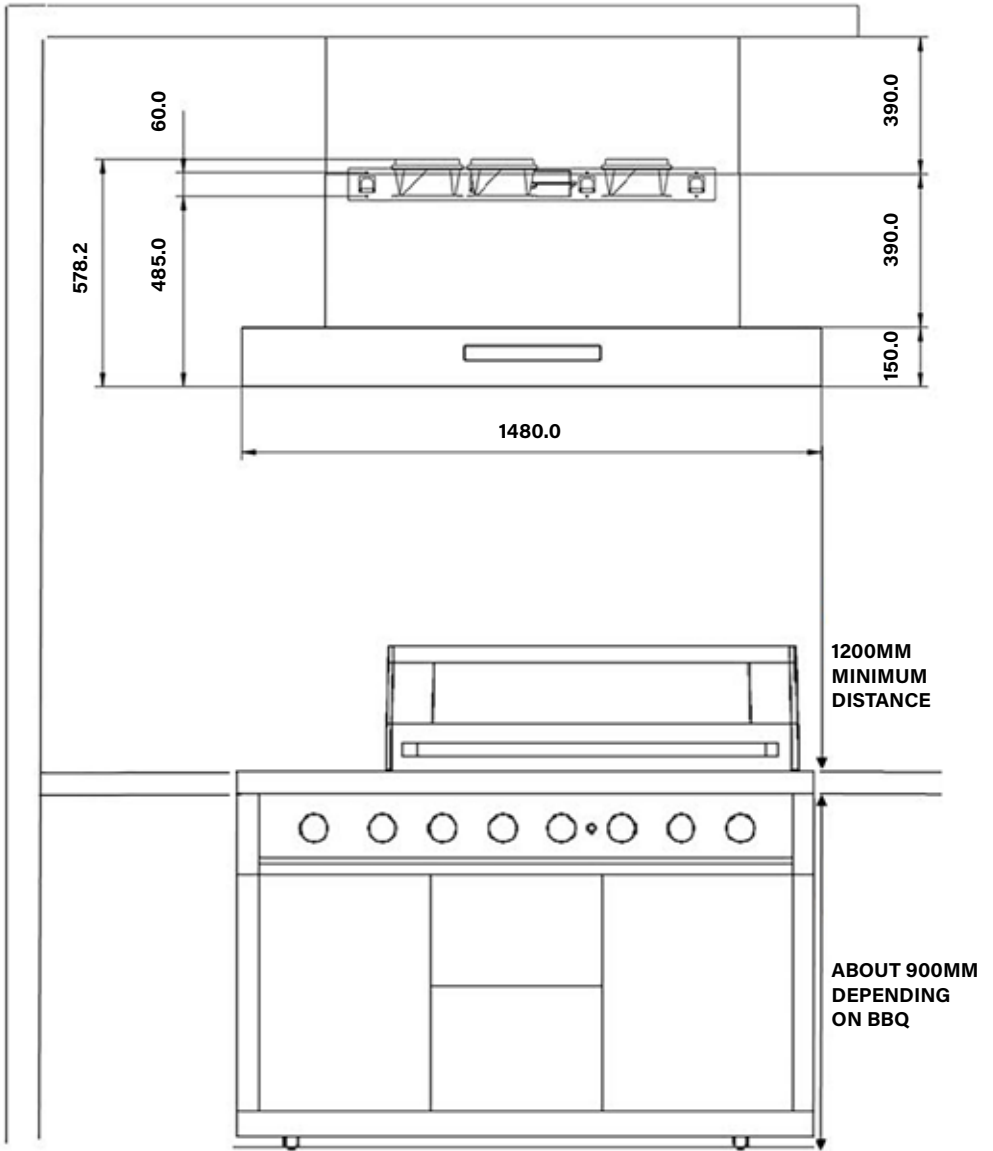

INSTALLING - WALL MOUNT CXWB12082BLK & CXWB14802BLK RANGEHOOD

DUCTING

1. Remove all packaging wrap from the ducts.
2. Position the ducting over the top of the collection box. Use duct tape to secure semi rigid ducting.
3. Duct through ceiling and roof in accordance with the local, state and national regulations and laws.

POWER

Using a plumb bomb or spirit level determine the vertical line the flue surrounds will take. The position of the 240V AC wall socket is that it must be accessible to turn on/off without removing any covers.

Note: All electrical work must be carried out by a licensed electrician.

1. Uncoil power cord.
2. Plug into wall socket and turn on.
3. Test the fans and lights work.
4. If everything works properly, turn off power at wall socket and unplug power lead.

FLUE SURROUND

Provided are 2 x flue surrounds both 400mm high. These are used to finish and cover the motor box and installed ducting.

1. Mounting the second flue surround, this goes on the inside of the one pre-installed flue cover.
2. Using a spirit level, plumb bob and tape measure position the flue bracket as high as possible. Once in correct position mark holes and drill.
3. Secure the flue bracket with suitable screws.
4. Slide the second flue cover inside the first. Make sure the power cord is clear of the flue surround. Now fasten to the flue bracket, make sure not to damage power cord.
5. Push 240V AC plug into power socket and turn on.

Note: Please only temporarily fix flue covers, so if service is required motors and electrical components can be accessed.

INSTALLING - CEILING MOUNT CXWB14802IS (ISLAND) RANGEHOOD

CEILING BRACKET

Note: Bracket must be level. If not Range hood will not operate correctly.

1. Using a plumb bomb mark on the ceiling the centre of your cooking surface.
2. Place the ceiling bracket on the ceiling. Ensure the sides and front are level with your cooking surface and that it is centre of the cooking surface.
3. Mark the mounting holes through the ceiling bracket. Note: Bracket must be screwed to the roofing framework not plasterboard.
4. The range hood is very heavy. Please use suitable fixings and hole size for this weight. If unsure of which fixings please discuss with your hardware stockist or range hood installer.
5. Securely fix the ceiling bracket to roofing framework. Ensure it is square to your cooking surface in the centre and level. Note: An uneven range hood will not operate correctly.
6. Using nuts and bolts attach 1 angle bracket to each corner of the ceiling bracket. Ensure nuts and bolts are tight.
7. Ensure you make allowances in the ceiling for your ducts before installing the range hood.

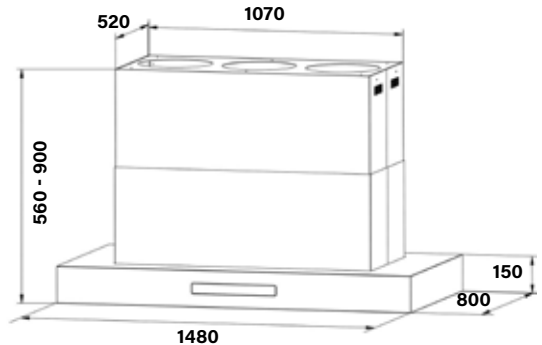

BRACKET MEASUREMENTS

(all measurements are in millimetres.)

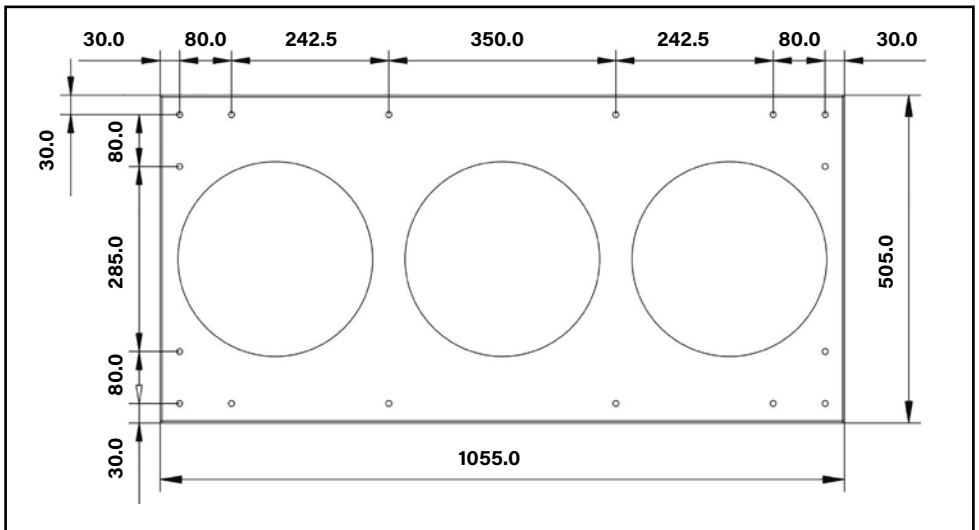

INSTALLING - CEILING MOUNT CXWB14802IS (ISLAND) RANGEHOOD

WARNING:

VERY HEAVY 2 PERSON LIFT.

1. Using nuts and bolts attach 1 angle bracket to each corner of the range hood motor box.
2. Slide the 2 flue surrounds over the top of the 4 angle brackets and onto the range hood body.

Note: The inner flue surrounds attach to the holes at the top of the ceiling bracket.

3. Lift and position the range hood so that the 8 angle brackets (4 top & 4 bottom) line up and can be screwed together using nuts and bolts.
4. Once secured check the distance between the cooking surface and the underside of the range hood this should be minimum 1200mm, maximum 1350mm.
5. If the distance is not correct adjust the range hood height up or down as required. Once correct securely tighten all nuts and bolts.
6. Check to ensure that the range hood is level side to side as well as front to back. Also check that it is square to the cooking surface. It is imperative that the range hood is level so that it operates correctly.

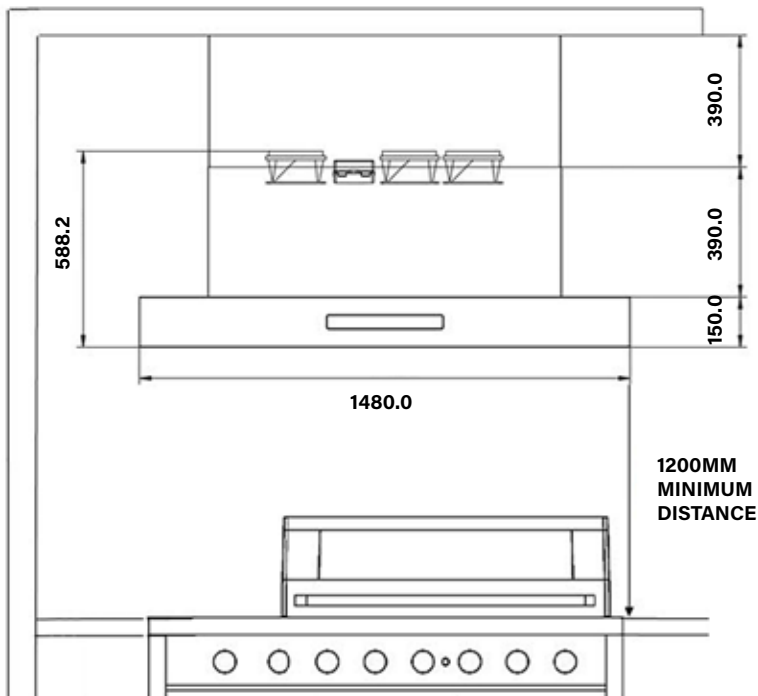

INSTALLING - CEILING MOUNT CXWB14802IS (ISLAND) RANGEHOOD

DUCTING

1. Remove all packaging wrap from the ducts.
2. Position the ducting over the top of the collection box. Use duct tape to secure semi rigid ducting.
3. Using a Range hood installer duct through the ceiling and roof in accordance with local, state and national regulations and laws.

POWER

If required, have a power point socket installed onto the ceiling next to the ceiling bracket. Allow at least 100mm from the ceiling bracket. The position of the 240V AC ceiling socket is that it must be accessible to turn off without removing any covers.

Note: All electrical work must be carried out by a licensed electrician.

1. Uncoil power cord
2. Plug into ceiling socket and turn on.
3. Test the fans and lights work
4. If all okay turn off ceiling socket and unplug power lead.

FLUE SURROUND

Provided are 2 x flue surrounds both 400mm high. These are used to finish and cover the motor box and installed ducting. You have already installed these to your range hood.

1. Slide the inner flue surround up as high as possible and secure with screws, ensuring not to damage the power cord.
2. Push 240V AC plug into power socket and turn on.

Note: Please only temporarily fix flu covers, so if service is required motors and electrical components can be accessed.

MOUNTING THE RANGEHOOD

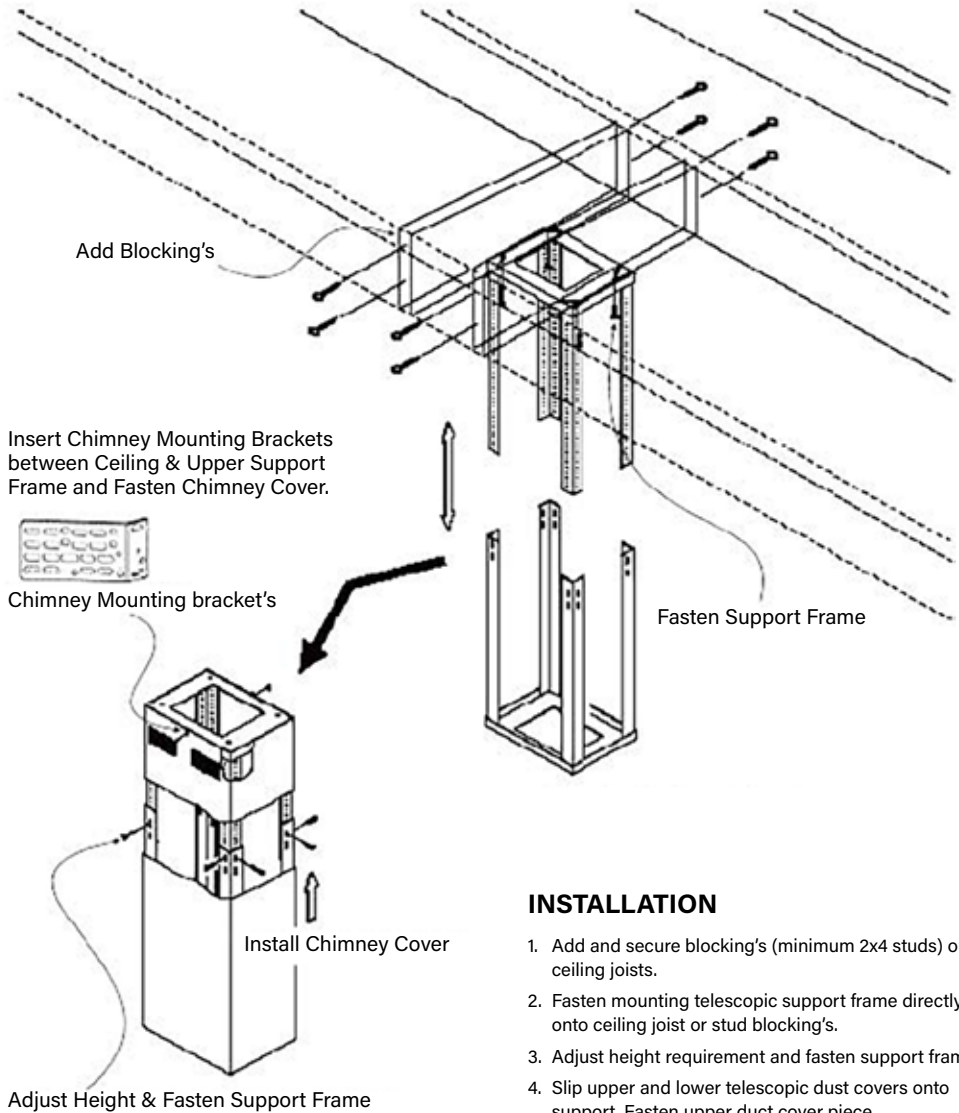

INSTALLATION

1. Add and secure blocking's (minimum 2x4 studs) onto ceiling joists.
2. Fasten mounting telescopic support frame directly onto ceiling joist or stud blocking's.
3. Adjust height requirement and fasten support frame.
4. Slip upper and lower telescopic dust covers onto support. Fasten upper duct cover piece.
5. Install duct work and electrical.
6. Install hood onto support frame and lower duct cover onto hood (next page).



Read all instructions before installing and operating this appliance.

IMPORTANT SAFETY NOTICE

Read all instructions in this manual before operating the appliance. Save these instructions for future reference.

Always leave safety grills and filter in place. Without these components, operating blowers could catch on to hair, fingers and loose clothing.

NEVER dispose cigarette ashes, ignitable substances or any foreign objects in to the blowers.

NEVER leave cooking area unattended. When frying, oil in the pan can easily overheat and catch fire. The risk of self-combustion is higher when the oil has been used several times.

OPERATION

Press the  to turn on the Rangehood. The display backlight will come on and the power icon will be displayed.

CONTROL PANEL



BUTTON	MAIN FUNCTION	TIMER SETTING FUNCTION	TIME SETTING FUNCTION
1 = LOW	Press 1 to turn the fan speed to LOW		
2 = MEDIUM	Press 2 to turn the fan speed to MEDIUM	Adjust timer MINUTES setting lower	Adjust HOURS time settings
3 = HIGH	Press 3 to turn the fan speed to HIGH	Adjust timer MINUTES setting higher	Adjust MINUTES time settings
DIGITAL SCREEN	Displays fan speed setting, Time and Timer		
LIGHT	Press to turn the LED lights ON & OFF		
TIMER	Use to set the Time and Delay-Off Timer		
POWER	Press to turn the Rangehood ON & OFF		

STANDBY MODE

Once the Rangehood is connected to power and turned on, it will enter into standby mode. Press the **POWER** button to start the Fan Motors or press the **LIGHT** button to turn on the LED lights.

DELAY OFF-TIMER

When the Rangehood is in standby mode press the **TIMER** button and hold for 1 second to turn the Delay Off-Timer ON.

The Delay Off-Timer is set to 1 minute by default, use the **2 (MEDIUM)** and **3 (HIGH)** buttons to adjust between 1 and 9 minutes.

The Delay Off-Timer will activate within 5 seconds after completing the timer adjustments. Once the Rangehood has reached the fixed duration time it will automatically shut off.

TIME

When the Rangehood is OFF, hold down the **TIMER** button for 3 seconds until the **TIMER** button light flashes. Use the **2 (MEDIUM)** button to adjust the **HOURS** and **3 (HIGH)** to adjust the **MINUTES**. If no button is pressed for 5 seconds during the **TIME** setting procedure then the Rangehood will exit the **TIME** setting function and return to OFF.

LIGHTS

Press the **LIGHT** button once to turn lights ON and once again to turn lights OFF. The Light settings are independent from all other settings (including Delay Off-Timer) the lights have to be manually turned ON or OFF.

FAN SPEED

The Rangehood fans have 3 speed settings, **LOW**, **MEDIUM** and **HIGH**. To set the desired fan speed press the buttons on the control panel marked **1** for **LOW**, **2** for **MEDIUM** and **3** for **HIGH**.

REMOTE CONTROL

Remote Control requires 2 x AAA batteries.

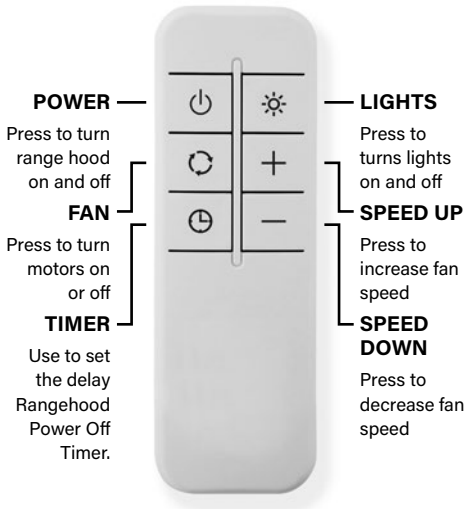

CLEANING

A build up of oil may occur if the Rangehood and baffle filters are not cleaned properly and regularly. Some discolouration of the baffle filter may occur if cleaned in the dishwasher.

RANGEHOOD SURFACES

Clean periodically with hot soapy water and a clean cotton cloth. Do not use abrasive detergent or steel wool/scouring pads which will scratch and damage the surfaces.

For heavier deposits, use a liquid degreaser.

After cleaning, you may use nonabrasive stainless steel polish/cleaners to polish and buff the stainless lustre. Always rub lightly, with a clean cotton cloth and with the grain of the stainless steel.

Note: Never wipe or rub across the grain as this will damage the surface finish.

BAFFLE FILTERS

The baffle filters fitted by the factory are intended to filter out residue and grease from cooking. They are required to be kept clean and should be cleaned at least once every two months, every 30 hours of operation or more often if required especially after heavy cooking.

Note: Always turn the Rangehood power point off before removing filters.

To Remove

Lift latch and gently pull down front of baffle filter and remove.

To Clean

1. Use warm soapy water and a soft cloth or put into dishwasher on a 'normal' cycle.
2. Thoroughly clean and wipe down the inside of Rangehood canopy.

To Fit

1. Position the rear of the baffle filter into the 2 slots.
2. Gently rotate the baffle filter into position, lift latch and push into place and release latch.

SPECIFICATIONS

ITEM No	CXWB12082BLK	CXWB14802BLK	CXWB14802IS
Body	304 Stainless Steel w/Matt Black Coating		316 Stainless Steel
Size (mm)	W1200 x D800mm	W1480 x D800mm	W1480 x D800mm
Filters	Stainless Steel Baffle Filters		
Rated Voltage	220-240V/50Hz		
Total Rated Power	482W	723W	
Motor Input Power	2 Motors x 238W each	3 Motors x 238W each	
LED Light Power	4 x 1.5W each	6 x 1.5W each	
Speed Control	3 Speed (Low, Medium, High)		
Air Volume (Gross)	2 Motors x 1300m ³ /h each	3 Motors x 1300m ³ /h each	
Noise Level (dB/Sone)	Approx. 25-35 dB/0.4-0.7 Sone per Motor		
Motor Type	Double Chamber Ultra Quiet		
Control Type	Touch Screen with Remote Control		
Semi-Rigid Ducting	2 x Ø150mm (round)	3 x Ø150mm (round)	
Flue Covers	2 x 400mm		
Installed Weight	60kg	75kg	85kg

Excelsior

For any queries or assistance call



Customer Service
(Australia Only)

1300 174 876

Hours of operation:
Monday to Friday 8am - 5pm EST

Do not return to place of purchase.
Keep your purchase receipt, this will be required to
make any claims under the 12 month warranty.