





Model Code: FRA340

### Included Accessories

		
ICM	UMG	6020

### Optional Accessories

		
DTA-18-316		

### Dimensions

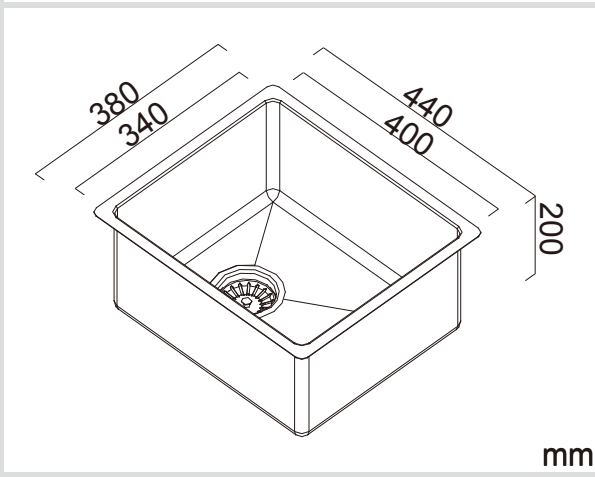

### Specifications

Description	Single bowl, Inset or flush-mount Undermount Sink
Overall Sink Size	380mm x 440mm x 200mm deep
Bowl Dimensions	340mm x 400mm x 200mm deep
Drainer Length	N/A
Thickness	1.2mm
Material	Stainless steel SUS316

### Installation

Fixings	Inset & Undermount clips supplied
Template	N/A
Min Cabinet Size	430mm
Waste Holes	1 x 90mm round Compatible with waste disposal
Sealing Strip	N/A

### Plumbing

Waste Fittings	1 x (90mm x 2") basket waste included
Overflow	N/A

### Packaging

Carton Type	EPS protection & Carton
Gross Weight	4Kg
Carton Size	465mm x 286mm x 513mm
Pack QTY	1

#### SURFACE FINISH



#### WASTE KIT

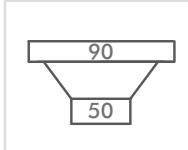

#### MATERIAL



#### INSTALLATION OPTIONS

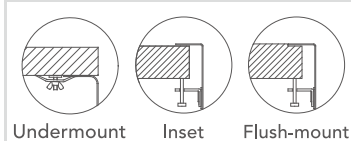

#### PROFILE

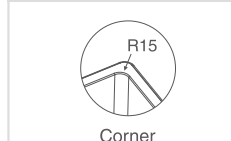

Abey are Australia's leaders in sinkware, designing and manufacturing to the world's highest quality specifications as well as sourcing and bringing you Europe's very best, leading edge designs – practical, affordable, inspirational, stylish, timeless or cutting edge. When you buy an Abey stainless steel sink you receive the highest quality and 25 year warranty. Abey and the manufacturer are continually seeking ways to improve the design specifications, aesthetic and production techniques of the products. As a result, alterations to the specifications and dimensions of the products and designs occur continually.