

Gasmate®

DELUXE BBQ RANGEHOOD

Model No. GR1200, GR1500



- Stainless steel finish
- 2 different widths, suits most 4 and 6 burner BBQ's
- GR1200 - maximum 2000m³ air flow
- GR1500 - maximum 3000m³ air flow
- LED lights at front of the rangehood
- Stainless steel baffle filters
- Remote control requires 2pcs "AAA" batteries to operate (not included)
- For outdoor use only
- Includes semi-rigid aluminium ducting

Important: Retain these instructions for future use.

WARRANTY TERMS & CONDITIONS

This warranty is not transferable to a subsequent purchaser if the product is sold by the original purchaser during the warranty period.

If a warranty fault appears within the warranty period, S.G.A. reserves the right to replace or repair the product.

In the event that S.G.A. chooses to replace the product, this original warranty will expire at the original date.

If the product includes various accessories or components, only the defective accessory or component will be replaced or repaired.

S.G.A. Reserves the right to replace defective parts of the product with parts and components of similar quality, grade and composition where an identical part or component is not available.

Products presented for repair may be replaced by refurbished products of the same type rather than being repaired. Refurbished parts may be used to repair the products.

To make a warranty claim, first contact S.G.A's Customer Service Line on the contact number below.

The purchase receipt for this product is to be retained and must be presented if making claim under the terms of this S.G.A. warranty.

Warranty repairs are free of charge, provided the product is delivered to our Service Department at 33-35 Lionel Road, Mt Waverley, Victoria, 3149 or to one of our Authorised Service Agents.

If a warranty fault is found the freight cost will be credited to the owner. If no fault is found the product will be returned and any costs associated with the service will be charged to the owner.

Products sent freight forward will not be accepted. In most cases the defective accessory or component only will need to be returned. The product or part of the product being returned must be adequately protected in a box.

S.G.A. will not be responsible for any in-transit loss or damage.

This warranty does not apply to any defect, deterioration, loss, injury or damage occasioned by or as a result of misuse or abuse, negligent handling or storage, normal wear and tear or if the product has not been installed and used in accordance with S.G.A.'s instructions, recommendations and specifications or if the product has been subjected to abnormal conditions. The warranty does not apply to blockages caused by insects or living organisms, as well as non-operating butterfly baffles or incorrectly installed ducts.

The warranty is void if there is evidence of the product being tampered with by unauthorised persons. The warranty does not extend to installation or disconnection costs.

Our goods come with guarantees that cannot be excluded under the Australian Consumer Law. You are entitled to a replacement or refund for a major failure and for compensation for any other reasonably foreseeable loss or damage. You are also entitled to have the goods repaired or replaced if the goods fail to be of acceptable quality and the failure does not amount to a major failure. The benefits of this warranty are in addition to any rights and remedies imposed by Australian State and Federal legislation that cannot be excluded.

Product Approved For Outdoor Use Only

For warranty claims, service, spare parts or products information in Australia, please call SITRO GROUP AUSTRALIA Pty Ltd on the Customer Service Line 1300 174 876.

A receipt or proof of purchase is required and must be kept for your records.

CONTACT DETAILS

Sitro Group Australia Pty Ltd
33-35 Lionel Road, Mt. Waverley
Victoria 3149, Australia
Tel (+613) 9543 9533
Fax (+613) 9543 9839
service.group@sitro.com.au

For any queries or assistance call



**Customer Service
Australia Only**

1300 174 876

Hours of operation:

Monday to Friday 8am - 5pm EST

Do not return to place of purchase.

36 Months Warranty Offer*

*12 Month Standard Warranty + 24 Month Extended warranty. Available when installation is completed by one of our recommended installers.



Scan QR code to view installer list and register your extended warranty.

INSTALLATION - OUTDOOR USE ONLY

Read all instructions before installing and operating this Rangehood.

This Rangehood is designed for use above an outdoor domestic gas (propane/natural) barbecue.

WHAT IS AN OUTDOOR AREA

An outdoor area is an open-air situation that is not obstructed by buildings, structures etc, facilitating correct combustion and allowing products of combustion to be readily dispersed to atmosphere.

An alfresco area, veranda or balcony (large area) is considered outdoors when it is an open-air situation with natural ventilation. This ensures stagnant areas do not form, as these prevent the products of combustion from being rapidly dispersed by wind and natural convection. In the unlikely event of a gas leak occurring, a well-ventilated area will allow escaping gases to rapidly disperse.

The following situations are considered to provide the natural ventilation required for an outdoor domestic barbecue or patio heater to be used:

- Four open sides with a roof or overhead cover.
- Four enclosed sides (walls) without a roof or overhead cover.
- Two parallel walls or two walls at right angles to each other with a roof or overhead cover.
- Three walls, with the one open side being at least 25 per cent of the total perimeter and the remaining three walls having an area of 30 per cent or more of unrestricted opening, with a roof or overhead cover.

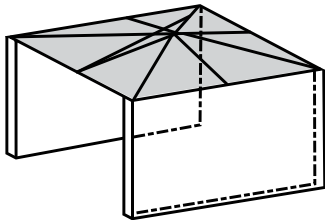

Parallel Walls

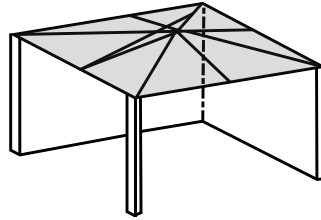

Right Angle Walls

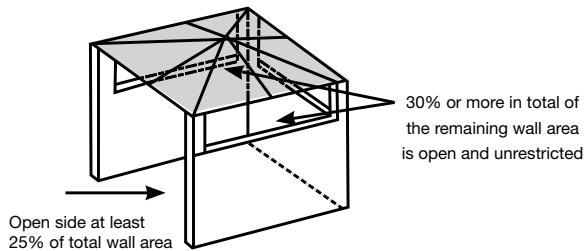

Electrical Data IMPORTANT SAFETY RULES

This rangehood is fitted with a sealed electrical connection plug that is compatible with the mains power supply for Australia / New Zealand and meets the requirements of Australian Standards. This rangehood must be connected to a supply voltage that is equal to that stated on the rating label. If the mains power connection plug or power cord becomes damaged it must be replaced with a complete assembly that is identical to the original, and this must be replaced by an authorised service centre. Always follow the Australian / New Zealand requirements for connection to the mains supply. If in doubt always consult a qualified electrician.

INSTALLATION - OUTDOOR USE ONLY

BALCONIES & VERANDAS

An outdoor barbecue or rangehood may be installed and used on a balcony or veranda if, by location and use, it will not cause a hazard and the manufacturer's instructions allow for such use. It may also be necessary to consult local building laws before installing or using a gas barbecue on a balcony or veranda.

A balcony or veranda shallow in depth and with a roof and three enclosed sides is considered an acceptable area if the following applies:

- the depth of the balcony or veranda is smaller than or equal to its height; and
- the open face width is at least twice the depth.

Examples of these situations:

- A balcony with an open construction balustrade (more than 75 per cent free open area). Measure the distance from floor to roof 'H'.
- The maximum allowable depth 'D' is the same as 'H' and the minimum width 'W' is twice 'D'.
- A balustrade is enclosed or has less than 75 per cent free open area. Measure from the top of the balustrade to the roof 'Ha'. The maximum allowable depth 'D' is the same as 'Ha' and the minimum width 'W' is twice 'D'.

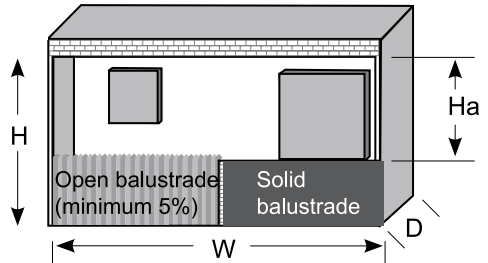

IMPORTANT

It is recommended that access doors or windows to the balcony or veranda be closed while the barbecue is in use. If unsure always consult with your local building authority and local gas authority.

IMPORTANT SAFETY NOTICE

- Disconnect the power supply when changing light bulbs.
- This appliance is not intended for use by persons (including children) with reduced physical, sensory or mental capacities, or lack of experience and knowledge, unless they have been given supervision or instruction concerning use of the appliance by a person responsible for their safety.
- Young children should be supervised to ensure that they do not play with the appliance.
- There shall be adequate ventilation of the room when the Rangehood is used at the same time as appliances burning gas or other fuels.
- There is a fire risk if cleaning is not carried out in accordance with the instructions. You must read the details concerning the method and frequency of cleaning.
- Do not flambé under the Rangehood.
- Exhaust air must not be discharge into an existing flue which is used for exhausting fumes from appliances burning gas or other fuels.
- The minimum distance between the hob surface and the lowest part of the Rangehood is 1200mm. This distance shall be at least 1200mm, if the Rangehood is installed over a barbecue. If the instructions for the barbecue specify a greater distance, this has to be taken into account.
- Attention should be given to ensure that any applicable regulations concerning the discharge of exhaust air is fulfilled.
- Note that accessible parts may become hot when used with cooking appliances.
- Remove any plastic coating from the product before use.
- Do not attempt to modify this appliance as this could cause injury and will void your warranty.
- Underside surfaces can become hot during use. Do not touch.
- Never leave barbecue unattended during use as fat fires and flare ups may occur.

- Always operate the product from a power source of the same Voltage, Frequency and Rating as indicated on the Product Identification Plate.
- Avoid leaving Rangehood operating when unattended.
- Avoid contact with moving parts. Keep hands, hair and clothing, well away from the product while it is in operation.
- Do not remove filters whilst Rangehood is operating.
- The appliance is fitted with removable filters. Ensure the filters are removed and thoroughly cleaned at least once every two months or every 30 hours in accordance with these instructions.
- There is a fire risk if cleaning is not carried out in accordance with the instructions.
- Do not use the product for other than its intended use as described in these instructions. This product is intended for Normal Domestic Household Use only.
- The power supply must be supplied through a residual current device (RCD) having a tripping current not exceeding 30mA.
- Incorrect installation is not covered under warranty.
- **WARNING- KEEP BATTERIES OUT OF REACH OF CHILDREN**
- Swallowing may lead to serious injury in as little as 2 hours or death, due to chemical burns and potential perforation of the oesophagus.
- If you suspect your child has swallowed or inserted a battery immediately call the 24-hour Poisons Information Centre on 13 11 26 for fast, expert advice.
- Examine devices and make sure the battery compartment is correctly secured, do not use if compartment is not secure.
- Dispose of used batteries immediately and safely. Flat batteries can still be dangerous.

PRIOR INSTALLATION - IMPORTANT NOTICE

Please read the entire instruction manual before installing the Rangehood.

The installation in this manual is intended for qualified installers, service technicians or persons with similar qualified backgrounds. DO NOT attempt to install this appliance yourself. Injury could result from installing the unit due to lack of appropriate electrical and technical background.

Always ensure this Rangehood is installed as per the requirements noted in the current revision of AS/NZS3000 (Wiring Rules).

There shall be adequate ventilation of the room when the Rangehood is used at the same time as appliances burning gas or other fuels (not applicable to appliances that only discharge the air back in to the room).

If the supply cord of this equipment is damaged, it must only be replaced by the manufacturer or its service agent or a similarly qualified person in order to avoid a hazard.

Always switch power off prior to installation.

All electrical work must be done in accordance with local and national electrical codes as applicable and installed by a licenced electrician.

For safety, this product must be earthed.

A power outlet should be within 1000mm of the power cord exit from the Rangehood.

The socket must be accessible and enable the end user to isolate the Rangehood from the power for the purpose of internal cleaning or maintenance.

Stainless steel or powder coat is very easily damaged during installation if abraded or knocked by tools. Protect the Rangehood with the cardboard box or plastic bag during installation.

All ducting must comply with local requirements, building codes and gas codes.

It is not recommended to use old duct work. It should be replaced if necessary to avoid the possibility of a grease fire. Check all joints on duct work to ensure proper connection all joints should be properly taped.

The Rangehood is designed for indoor undercover use only and must be in a dry location.

Suitable fixings will be required to mount this Rangehood. These are not included.

Note that accessible parts may become hot when used with cooking appliances.

The power supply must be supplied through a residual current device (RCD) having a tripping current not exceeding 30mA.

Incorrect installation is not covered under warranty.

CONTENTS

Medium - GR1200

- 1 x Rangehood with 2 x 150mm duct adaptors fitted
- 2 x Chimney covers each 250mm high
- 1 x Chimney mounting bracket top
- 2 x Semi-rigid aluminium ducts 150mm x 2m

Large - GR1500

- 1 x Rangehood with 2 x 150mm duct adaptors fitted
- 2 x Chimney covers each 250mm high
- 1 x Chimney mounting bracket top
- 3 x Semi-rigid aluminium ducts 150mm x 2m

REQUIRED FOR USE

Accessible power pointed fitted within 1m of Rangehood mounting position. The power point must be supplied through a residual current device (RCD) having a tripping current not exceeding 30mA.

TYPICAL EQUIPMENT REQUIRED FOR INSTALLATION

- Electric drill
- Suitable mounting hardware
- Drills
- Screwdriver
- Tape measure/rule
- Plumb bob
- Spirit level
- Ladder

For ducting:

- Duct tape
- Jigsaw
- Duct elbows as required for correct installation
- Roof cap or duct exit as required for correct installation

BEFORE INSTALLING

Please consider the following important items before commencing to install the rangehood:

1. The rangehood must be ducted to an external exit point to ensure it operates and complies with local and national regulations. Vertical exit through the roof is highly recommended to provide the best performance, (See Diagram 1).
2. Avoid sharp bends in the duct – ideal bend radius should be at least 2 x duct diameter (R300mm minimum), (See Diagram 2).
3. The rangehood should be sized to larger than the cooking surface of the BBQ (including any side burners) to ensure adequate extraction of smoke and fumes, (See Diagrams 3 & 4).
4. When fitted above a BBQ with hood, consideration should be taken to create a bulkhead behind the rangehood to bring it forward from where the open hood is. This will ensure the best extraction of the smoke and fumes and minimise impact of hood deflecting smoke away from the rangehood, (See Diagrams 5 & 6).
5. Each fan motor must be ducted separately (do not combine to a single outlet).
6. Do not reduce the duct size smaller than $\text{Ø}150\text{mm}$.
7. Total length to exits is recommended to be less than 4m.
8. Do not crush, compress or deform the duct.

Diagram 1:
RANGEHOOD EXIT

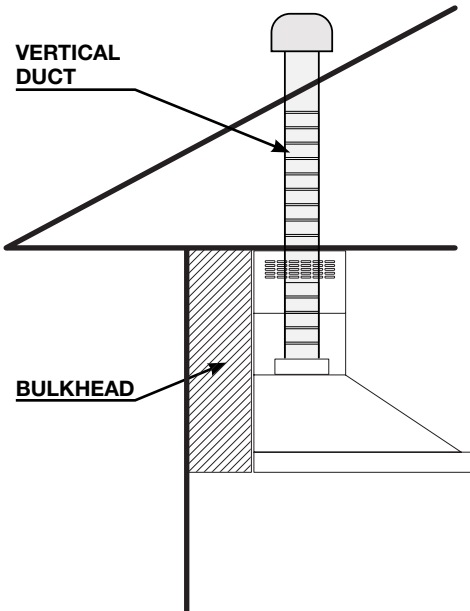

WARNING - FIRE

NEVER Exhaust air or terminate duct work into spaces between walls, crawl spaces, ceilings, attics or garages. All exhaust must be ducted to the atmosphere.

Use Metal duct work only.

Fasten all connections with sheet metal screws and tape all joints with certified Silver tape or duct tape.

The rangehood kit includes semi-rigid aluminium ducting. In the case additional ducting is required, it is highly recommended that semi-rigid aluminium ducting or fully rigid metal duct is used. Fully rigid metal ducting will further improve the airflow of the rangehood

Diagram 2:
DUCT BENDS

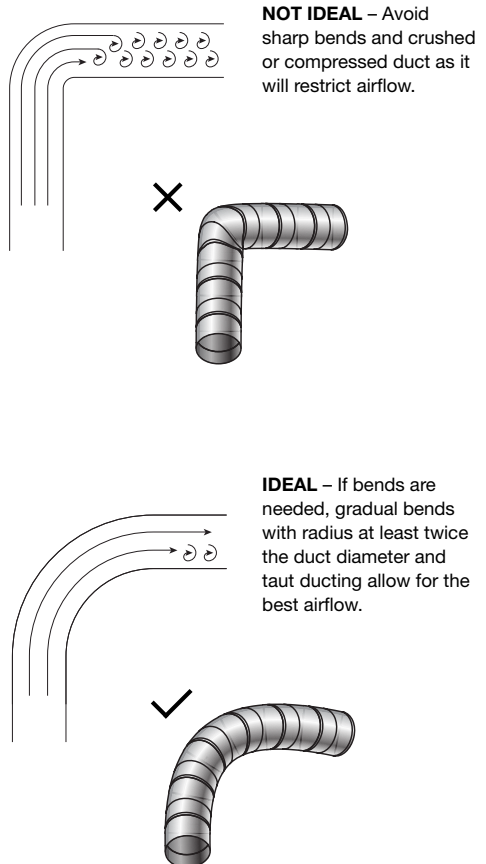

RANGEHOOD SIZING AND POSITION

Diagram 3:
SIZED TOO
SMALL

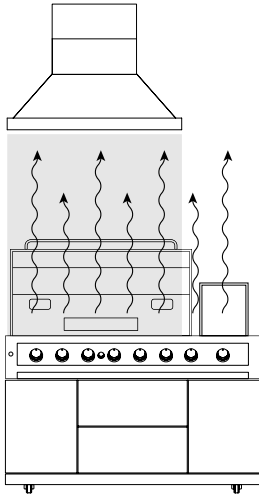

NOT IDEAL – Rangehood does not overlap with BBQ cooking area and smoke and fumes can easily escape away from the rangehood.

Diagram 4:
SIZED
CORRECTLY

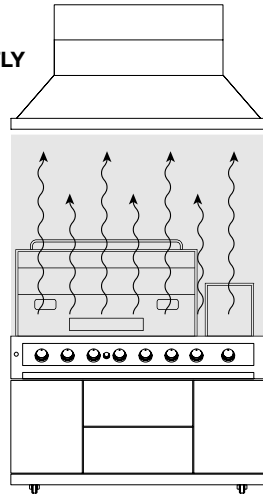

IDEAL – Rangehood overlaps complete cooking area of the BBQ to help ensure it captures the maximum level of fumes and smoke.

Diagram 5:
SMOKE
ESCAPES
RANGEHOOD

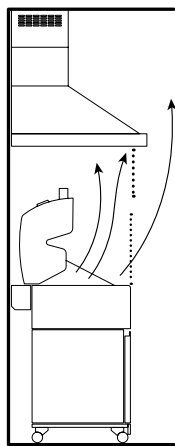

NOT IDEAL - Hood deflects smoke and fumes and away from the rangehood.

Diagram 6:
FORWARD TO
COMPENSATE
FOR BBQ HOOD



BULKHEAD

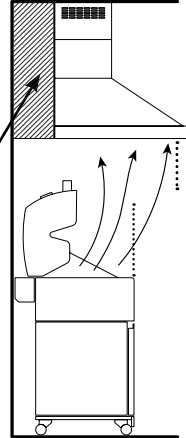

IDEAL – Bulkhead to allow rangehood to be positioned slightly forward of the cooking area to catch smoke and fumes effectively.

RANGEHOOD INSTALLATION - GR1200

The ideal position of the Rangehood is as follows:

1. Height above cooking surface – 1200mm
2. Distance from cooking surface to Rangehood mounting bracket bottom screw hole:
 - Top mounting holes – 1598mm

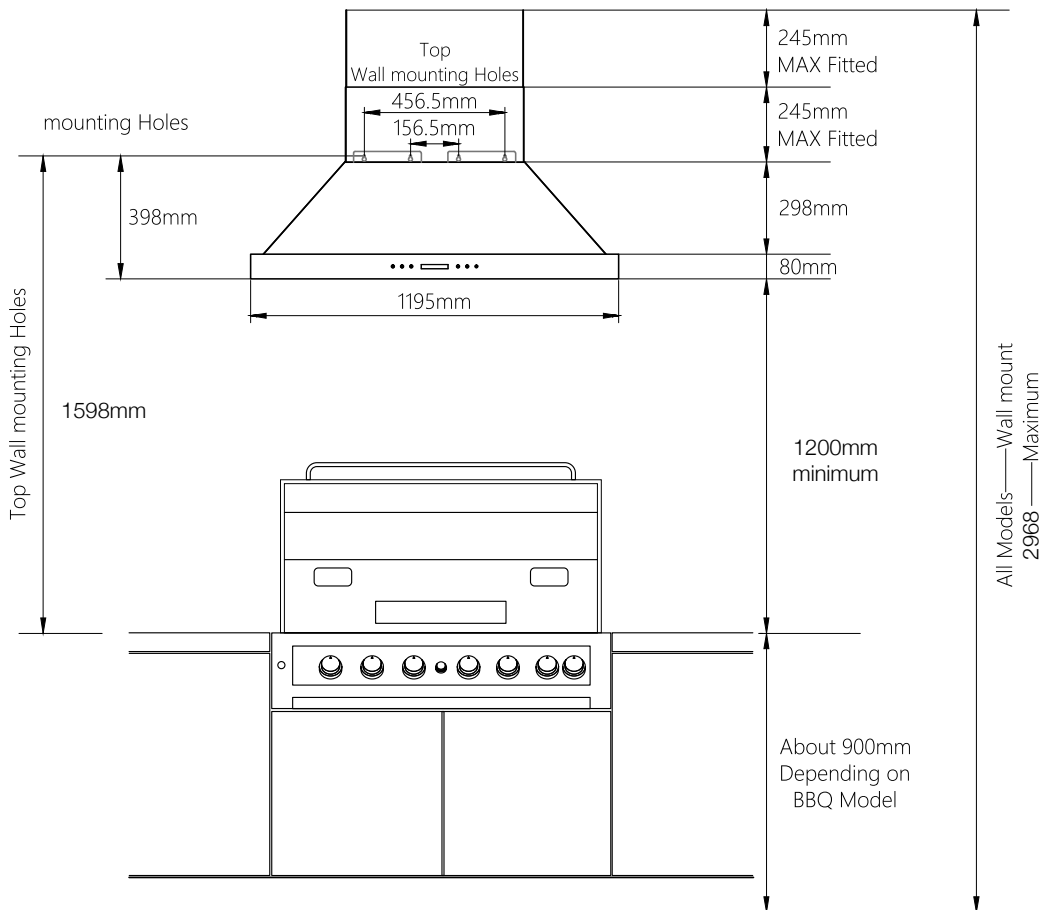

RANGEHOOD INSTALLATION - GR1500

The ideal position of the Rangehood is as follows:

1. Height above cooking surface – 1200mm
2. Distance from cooking surface to Rangehood mounting bracket bottom screw hole:
 - Top mounting holes – 1598mm

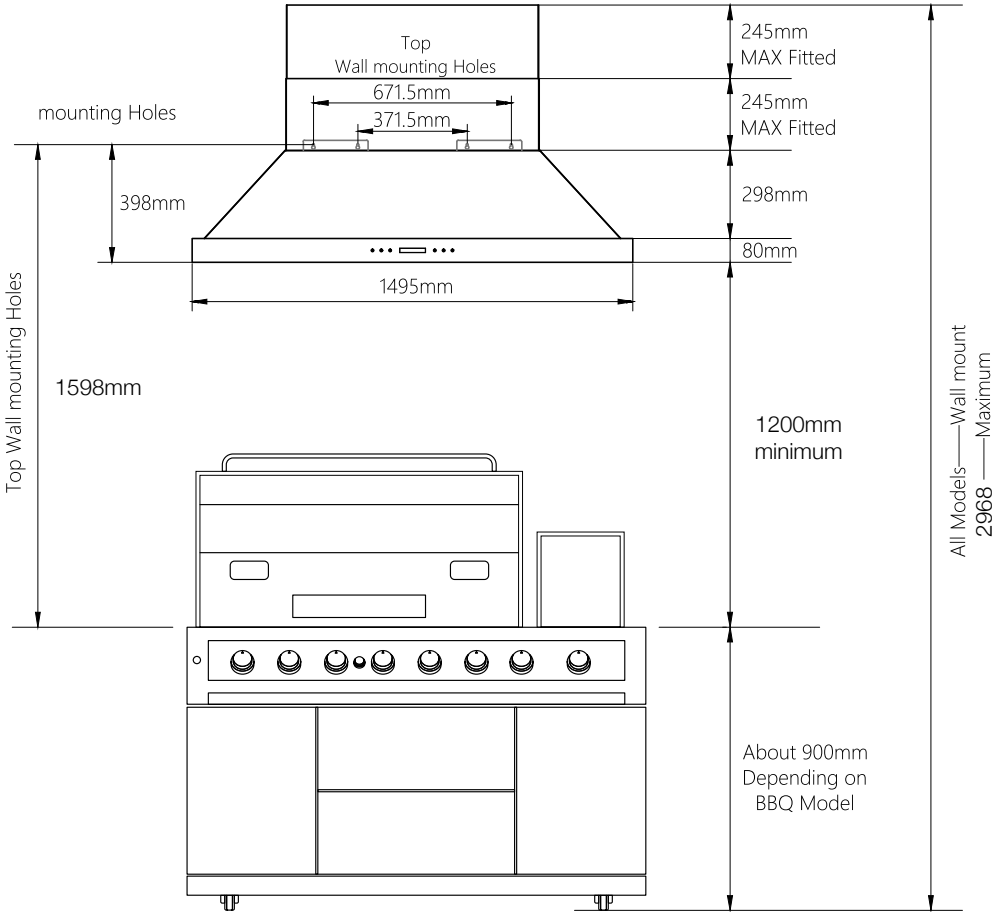

GENERAL ASSEMBLY

1. Place the rubber seal flat onto the top of the rangehood, lining up the 6 holes in the seal correctly with the holes in the rangehood top.
2. Place the ducting adapter with the butterfly flaps on top of the seal again ensuring that the holes line up correctly.



3. Secure with the 6pcs screws per duct adapter.
4. Install both wall plates to each side using the 6pcs screw per mounting plate

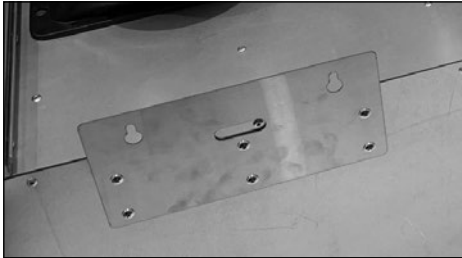

You can now proceed with the installation instructions.

INSTALLING - WALL MOUNT RANGEHOODS

Note: Rangehood must be level, if not the rangehood will not operate correctly.

1. Using a tape measure mark the level of the mounting holes, refer diagrams on pgs 9-10, above cooking surface. This line should be level.
2. Find the centre of the BBQ cooking surface and using a plumb bob, mark this centre on the above mentioned mounting hole level line.
3. Mark the mounting hole locations along the mounting hole level line. These marks should be either side of the centre mark made in step 2, refer diagrams on pgs 9-10.
4. Your rangehood is very heavy. Please use suitable fixings and hole size for this weight.
Medium – 42Kg
Large – 45Kg
5. If unsure of which fixings please discuss with your hardware stockist or rangehood installer.
6. Using two people, lift rangehood into place and secure to the wall using selected hardware. Ensure rangehood is level.

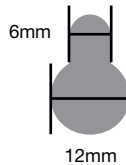

**Mounting
Bracket Slot
Dimensions**

INSTALLING - WALL MOUNT RANGEHOOD

DUCTING

1. Remove all tape from the ducts butterfly flaps and ensure they move up and down freely.
2. Position the butterfly flaps up.
3. Position the ducting over the top of the collection box and butterfly flaps. Note: If unsure about the ducting please contact a rangehood installer.
4. If using a rangehood installer or roof plumber duct through ceiling and roof in accordance with the local, state and national regulations and laws.

POWER

Using a plumb bob or spirit level determine the vertical line the flue surrounds will take.

The position of the 240V AC wall socket is that it must be accessible to turn on/off without removing any covers.

Note: All electrical work must be carried out by a licensed electrician.

1. Uncoil power cord.
2. Plug into wall socket and turn on.
3. Test the fans and lights as per "Using Rangehood".
4. If all okay turn off wall socket and unplug power lead.

FLUE SURROUND

Provided are 2 x flue surrounds both 400mm high. These are used to finish and cover the motor box and installed ducting.

1. Lift and fit bottom flue surround, this fits into the groove in the Rangehood flat top.
2. Mark 1 hole on each side for the flue surround. Remove flue surround and drill holes.
3. Replace flue surround and secure each side at the top with suitable screws.
4. Mounting the second flue surround, this goes on the inside of the one previously installed.
5. Using a spirit level, plumb bob and tape measure position the flue bracket as high as possible. Once in correct position mark holes and drill.
6. Secure the flue bracket with suitable screws.
7. Slide the second flue cover inside the first. Make sure the power cord is clear of the flue surround. Now fasten to the flue bracket, make sure not to damage power cord.
8. Push 240V AC plug into power socket and turn on.

Note: Do not damage the power cord during the flue surround installation.

CLEANING

A build up of oil may occur if the Rangehood and baffle filters are not cleaned properly and regularly. Some discolouration of the baffle filter may occur if cleaned in the dishwasher.

RANGEHOOD SURFACES

Clean periodically with hot soapy water and a clean cotton cloth. Do not use abrasive detergent or steel wool/scouring pads which will scratch and damage the surfaces.

For heavier deposits, use a liquid degreaser.

After cleaning, you may use nonabrasive stainless steel polish/cleaners to polish and buff the stainless lustre. Always rub lightly, with a clean cotton cloth and with the grain of the stainless steel.

Note: Never wipe or rub across the grain as this will damage the surface finish.

BAFFLE FILTERS

The baffle filters fitted by the factory are intended to filter out residue and grease from cooking. They are required to be kept clean and should be cleaned after every 30 hours of use or more often if required or after heavy cooking.

Note: Always turn the Rangehood power point off before removing filters.

To Remove

Lift latch and gently pull down front of baffle filter and remove.

To Clean

1. Use warm soapy water and a soft cloth or put into dishwasher on a 'normal' cycle.
2. Thoroughly clean and wipe down the inside of Rangehood canopy.

To Fit

1. Position the rear of the baffle filter into the 2 slots.
2. Gently rotate the baffle filter into position, lift latch and push into place and release latch.



Read all instructions before installing and operating this appliance.

IMPORTANT SAFETY NOTICE

Read all instructions in this manual before operating the appliance. Save these instructions for future reference. Always leave safety grills and filter in place. Without these components, operating blowers could catch on to hair, fingers and loose clothing. NEVER dispose cigarette ashes, ignitable substances or any foreign objects in to the blowers. NEVER leave cooking area unattended. When frying, oil in the pan can easily overheat and catch fire. The risk of self-combustion is higher when the oil has been used several times.

OPERATION

The control panel and the remote operate in the same way. Press the to turn on the rangehood. The display backlight will come on and the power icon will be displayed.

CONTROL PANEL

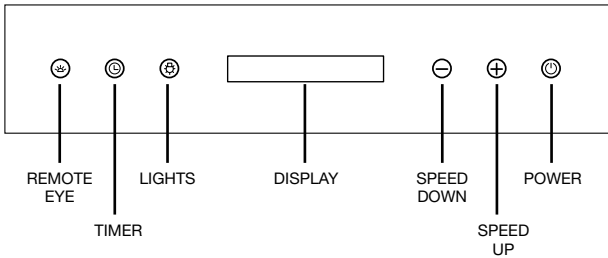

REMOTE CONTROL

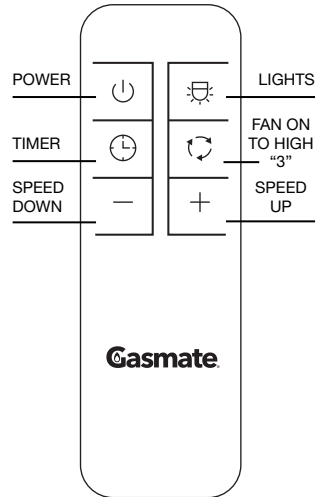

DISPLAY PANEL

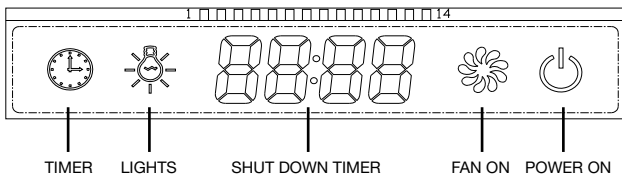

FAN

Press the "-" and the fan speed will start at low "1". Press the "+" and the fan speed will start at high "3". Press the and the fan will start on high "3". To adjust the fan speed use the "-" or "+" and the fan speeds will cycle through 1, 2 or 3 (Low, Medium, High) To turn off press the and the fan will stop. Note the fan icon will appear in the display whenever the fan is running. The fan icon will rotate to indicate the fan speed.

LIGHTS

The button turns the 4 lights on and off.

SHUT DOWN TIMER

To activate the 3 minute delayed shutdown. With the fans running, press the button. The fans will continue to run, the display will show 03:00 minutes, count down to zero, then switch off the fans. To cancel the delayed shut down, press the button.

CHANGING REMOTE BATTERY

WARNING- KEEP BATTERIES OUT OF REACH OF CHILDREN

- Swallowing may lead to serious injury in as little as 2 hours or death, due to chemical burns and potential perforation of the oesophagus.
- If you suspect your child has swallowed or inserted a battery immediately call the 24-hour Poisons Information Centre on 13 11 26 for fast, expert advice.
- Examine devices and make sure the battery compartment is correctly secured. Do not use if compartment is not secure.
- Dispose of used batteries immediately and safely. Flat batteries can still be dangerous.
- Tell others about the risk associated with button batteries and how to keep their children safe.

Battery Position

To fit or replace batteries "AAA" x 2pcs (Not Included);

1. Turn the remote over.
2. Push cover in and slide down to remove.
3. Remove old batteries if fitted and safely dispose of immediately.
4. Place new batteries (not included) "AAA" x 2pcs into the battery compartment as indicated on the remote control.
5. Securely push the cover back into position.

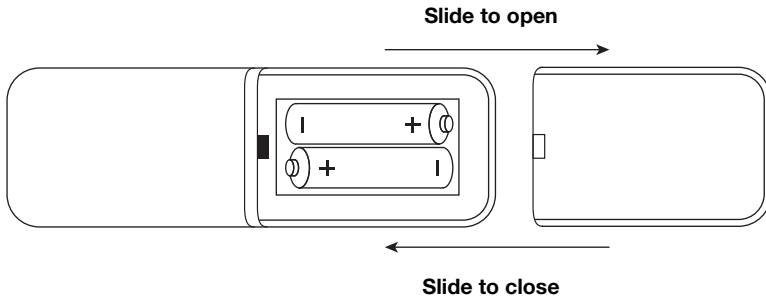

SPECIFICATIONS

GR1200

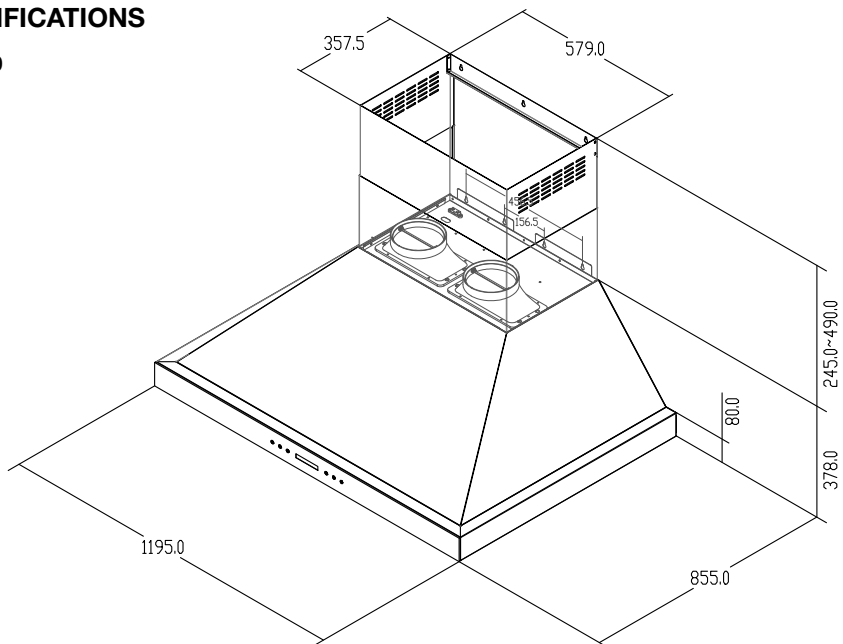

SPECIFICATIONS

GR1500

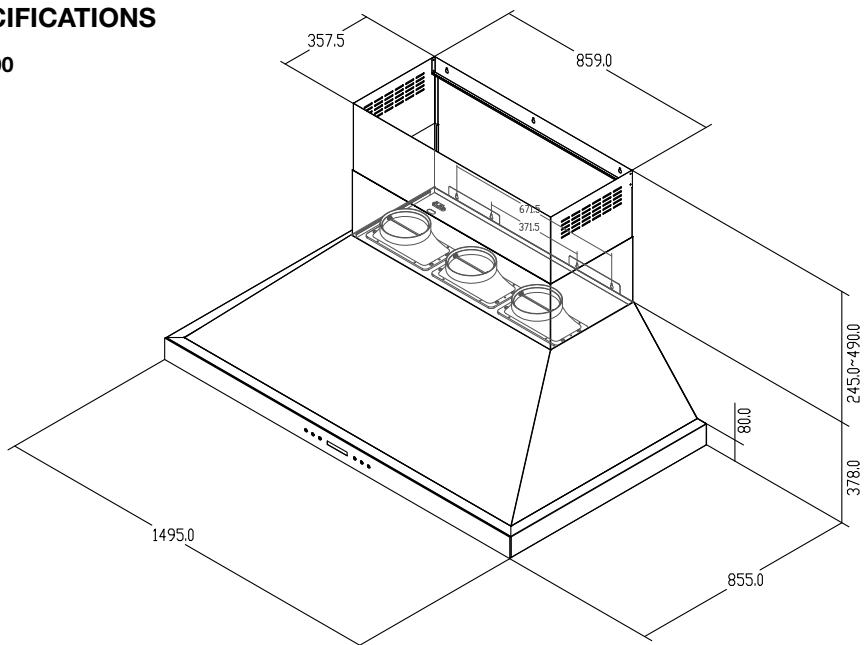

Description	GR1200	GR1500
Finish	Marine grade stainless steel #316	
Size (mm)	1200 W x 800 D	1500 W x 800 D
Total Height	378mm - Not including flue covers	
Height Above Cooking Surface	1200mm - Minimum	1250mm - Maximum
Air Volume, Gross	2000m ³	3000m ³
Noise	≤ 80db	
Motors - Electric induction	2	3
Lighting - Cool white	3 x Rectangle LED	4 x Rectangle LED
Controls	1 x touch controls and remote control	
Remote Control Batteries	"AAA" x 2pcs (Not Included)	
Flues - Always duct individually	2	3
Duct Diameter	150mm	
Flue Surround	2 at 250mm high	
Filters	Stainless steel #316 baffle style	
Ducts - Semi-rigid aluminium Total expanded length 2m each	2	3
Weight	42Kg	45Kg

For any queries or assistance call



Customer Service
(Australia Only)

1300 174 876

Hours of operation:
Monday to Friday 8am - 5pm EST

Do not return to place of purchase.
Keep your purchase receipt, this will be required to
make any claims under the 1 year warranty.

Gasmate®